

Chen Notation

„Ein Bild wird von genau einem Fotografen erstellt“

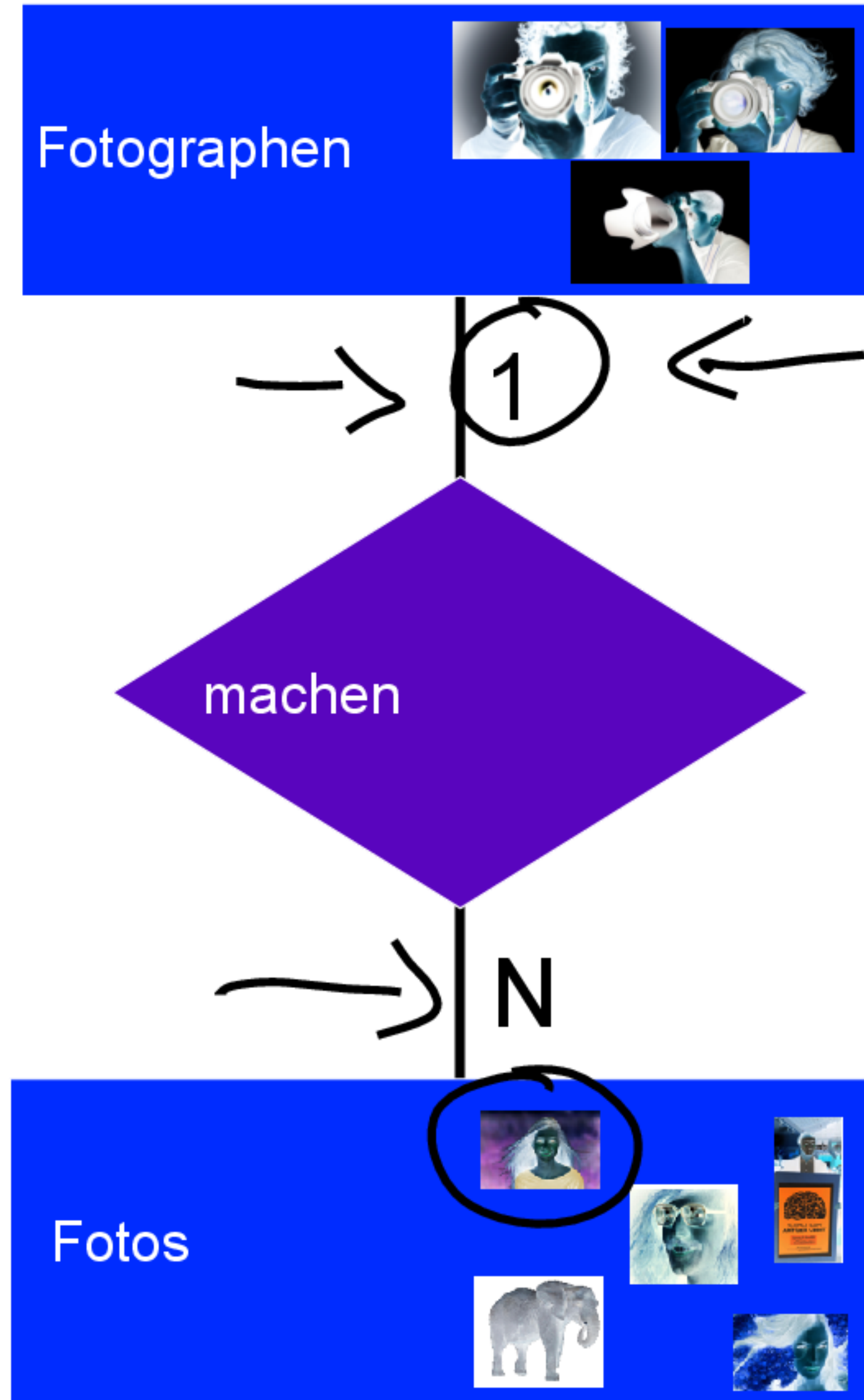

min/max Notation

„Ein Bild wird von genau einem Fotografen erstellt“

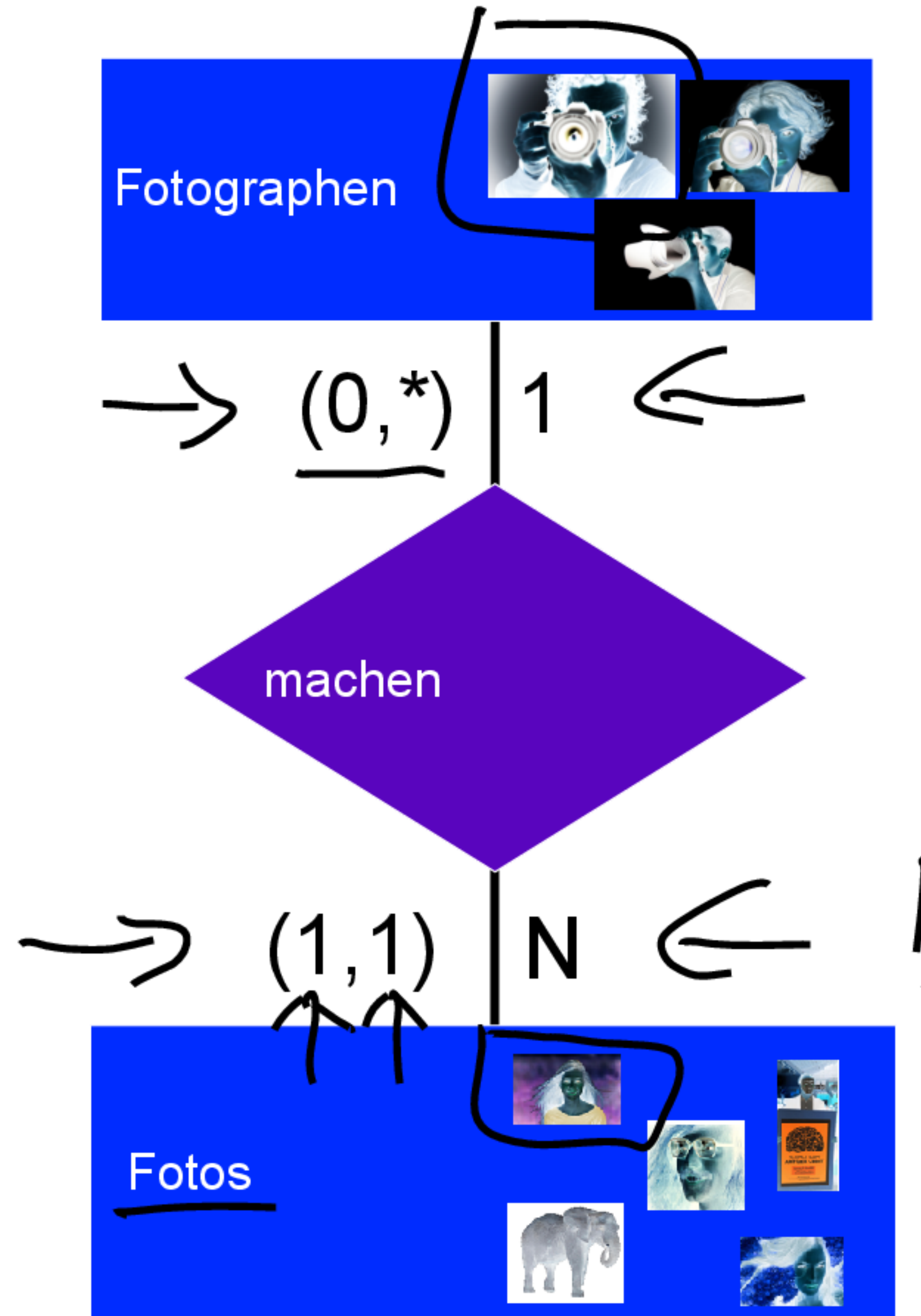

Chen versus min/max

1:1 Beziehung

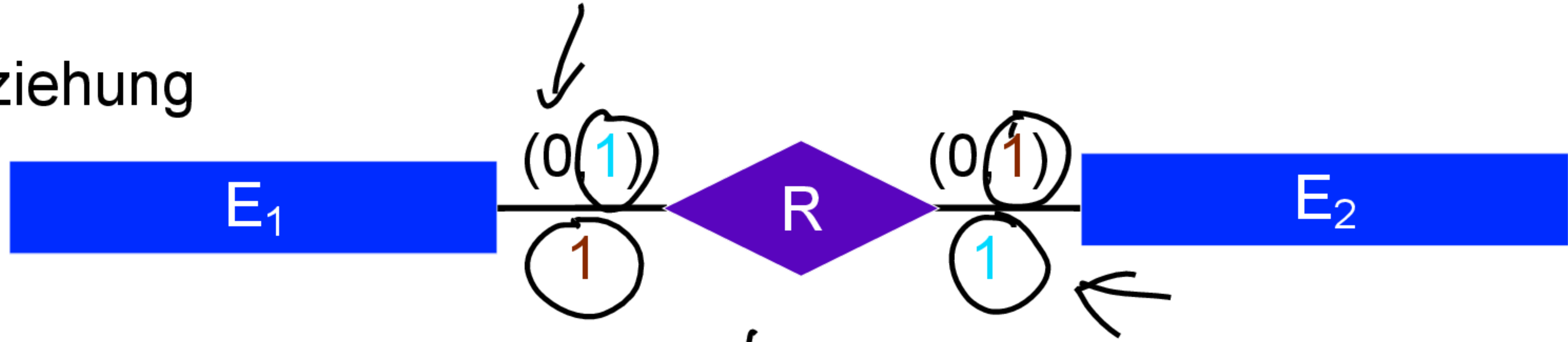

1:N Beziehung

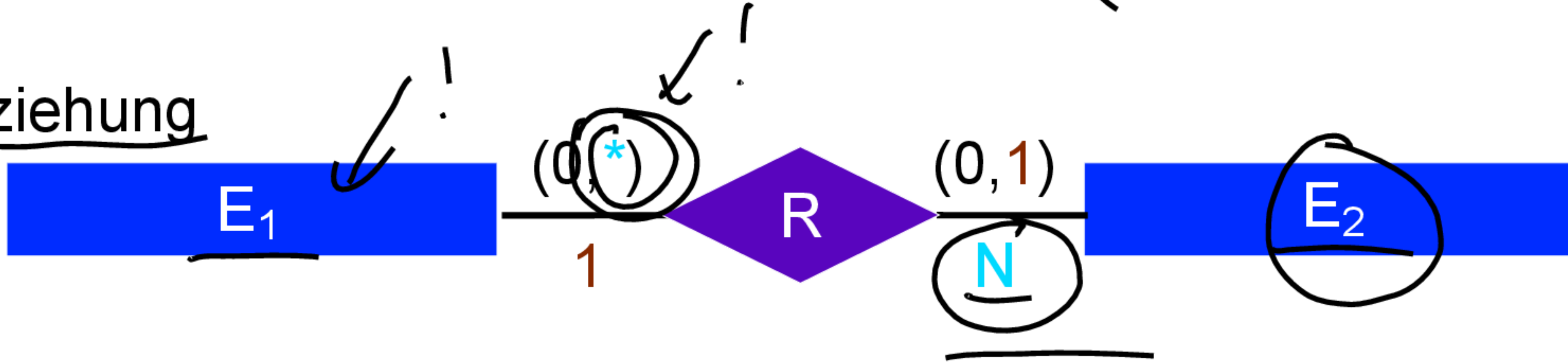

N:M Beziehung

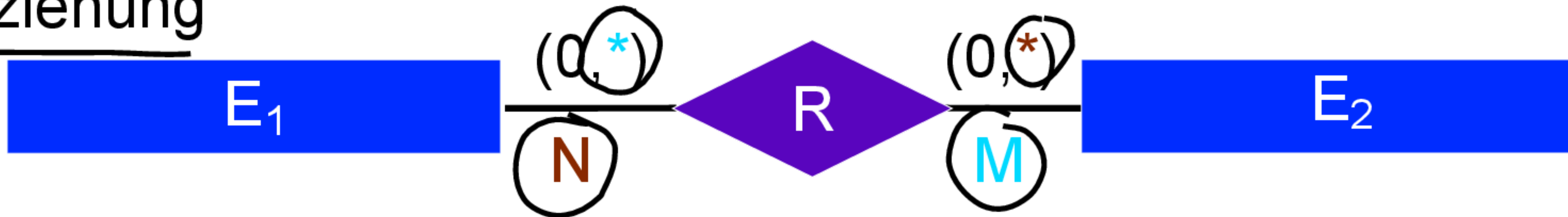

Mehrstellige Beziehungen

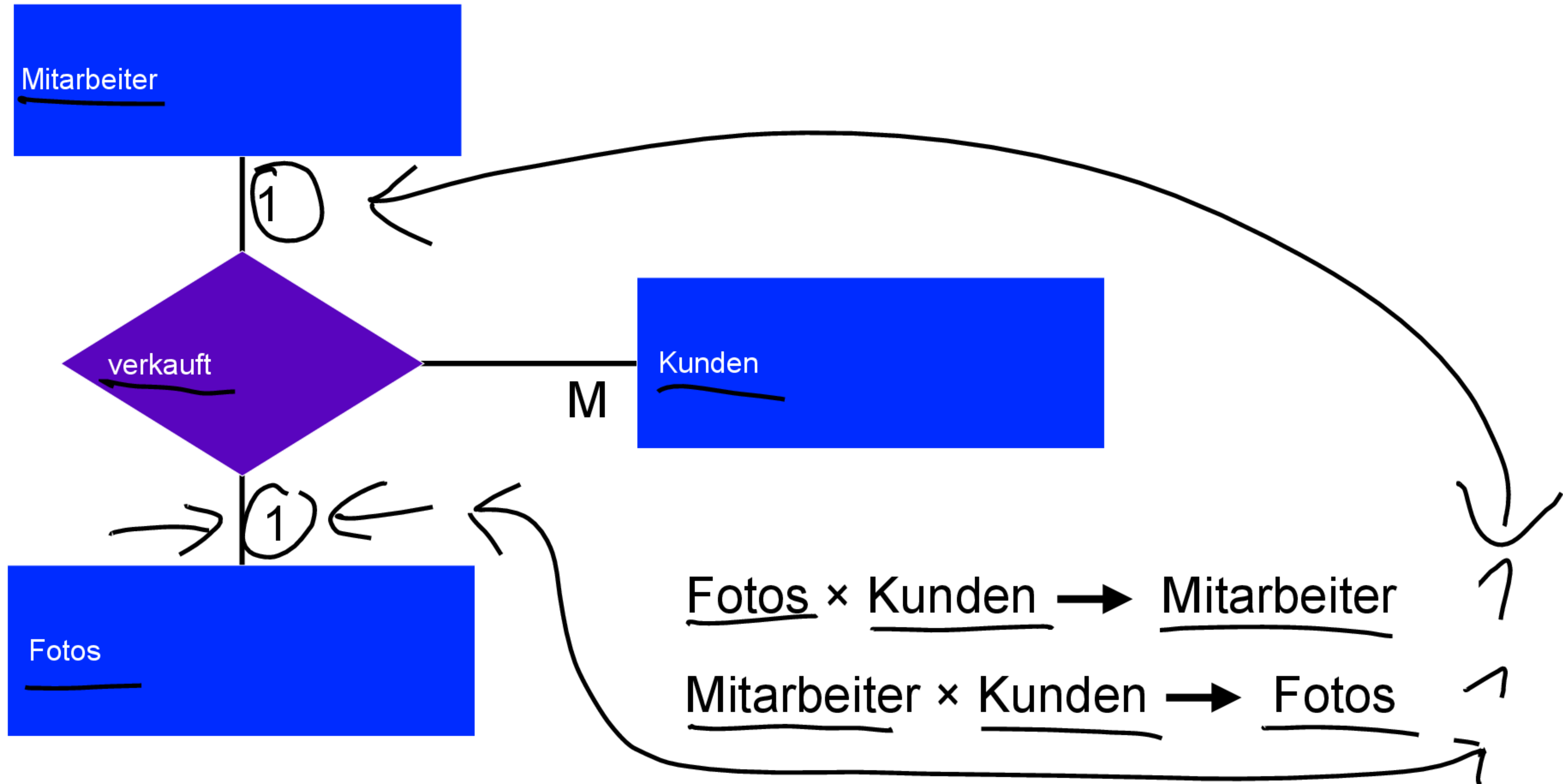

Mehrstellige Beziehungen

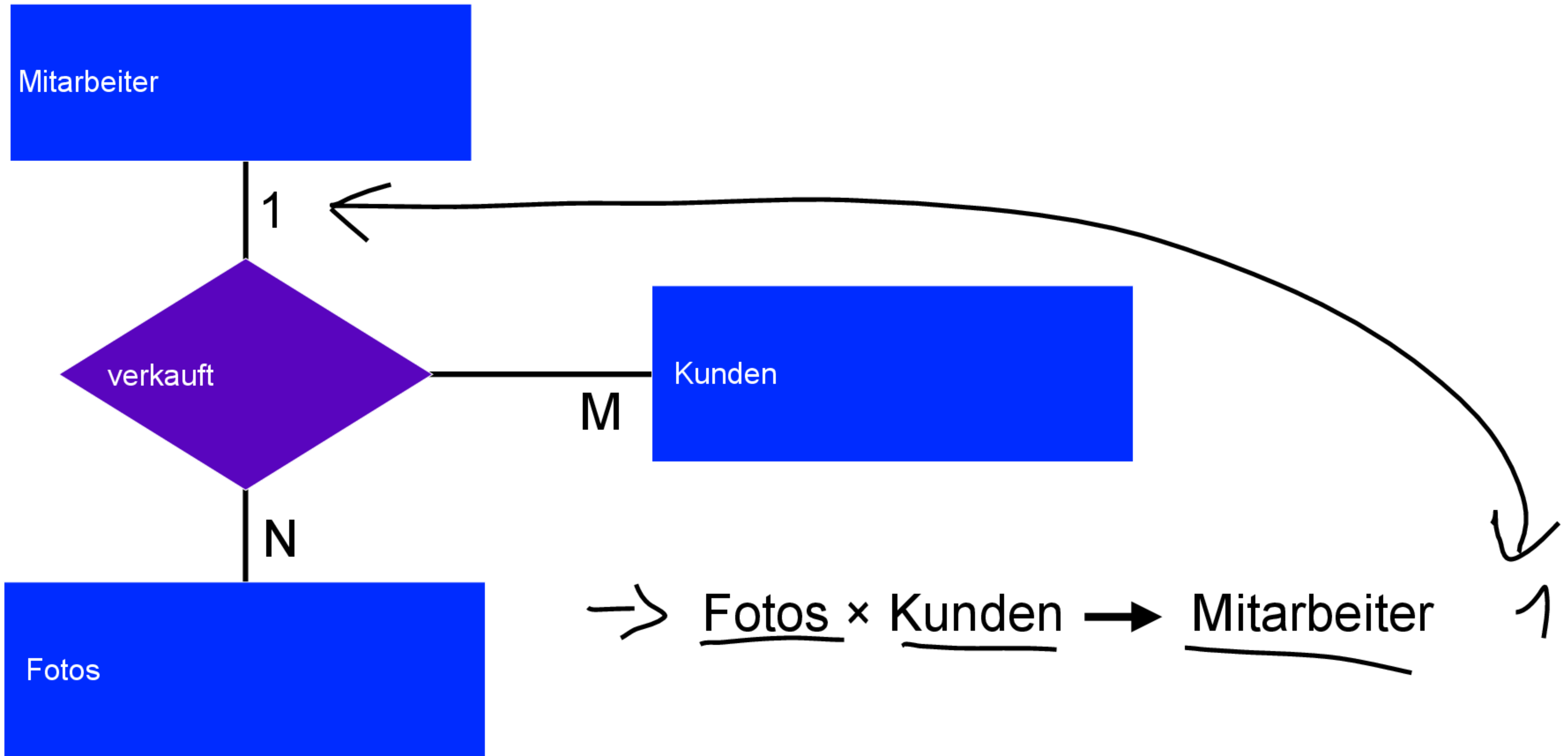

Mehrstellige Beziehungen mit min/max

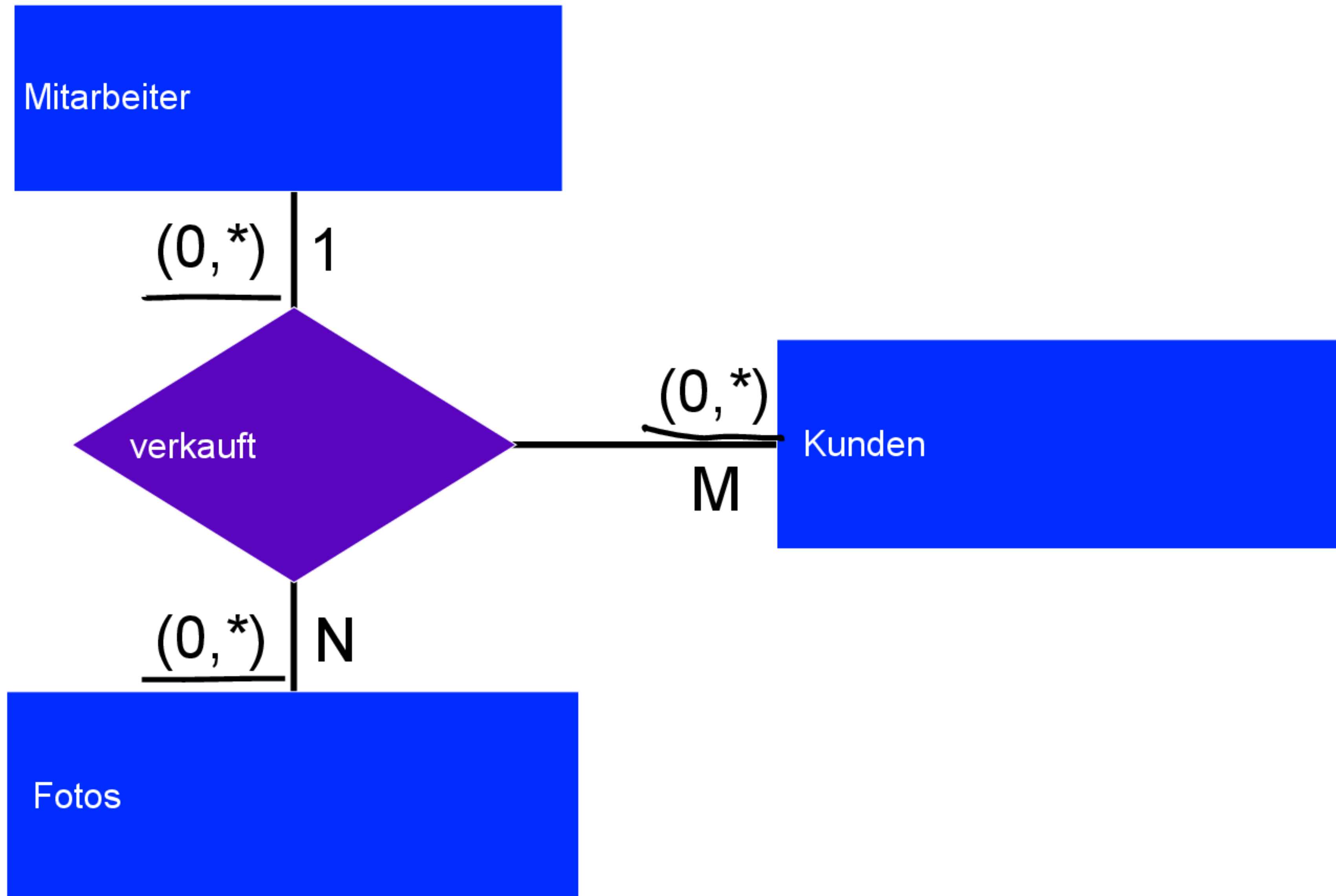

Leserichtung der Notationen

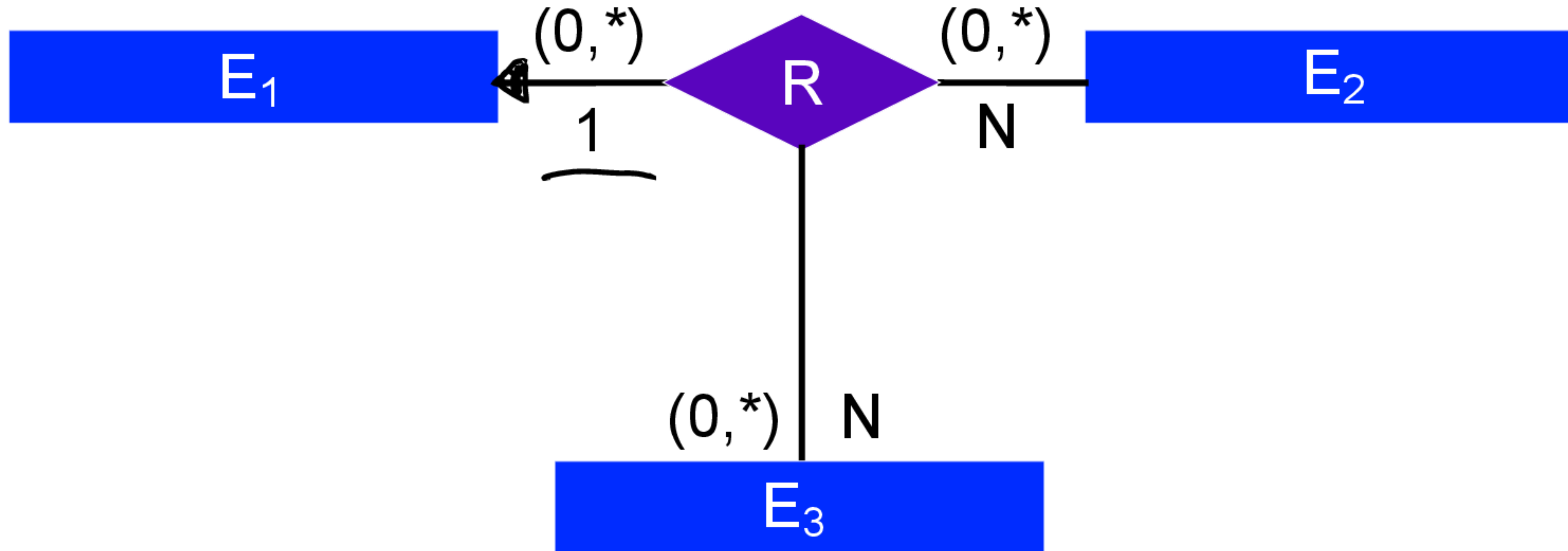

Leserichtung der Notationen

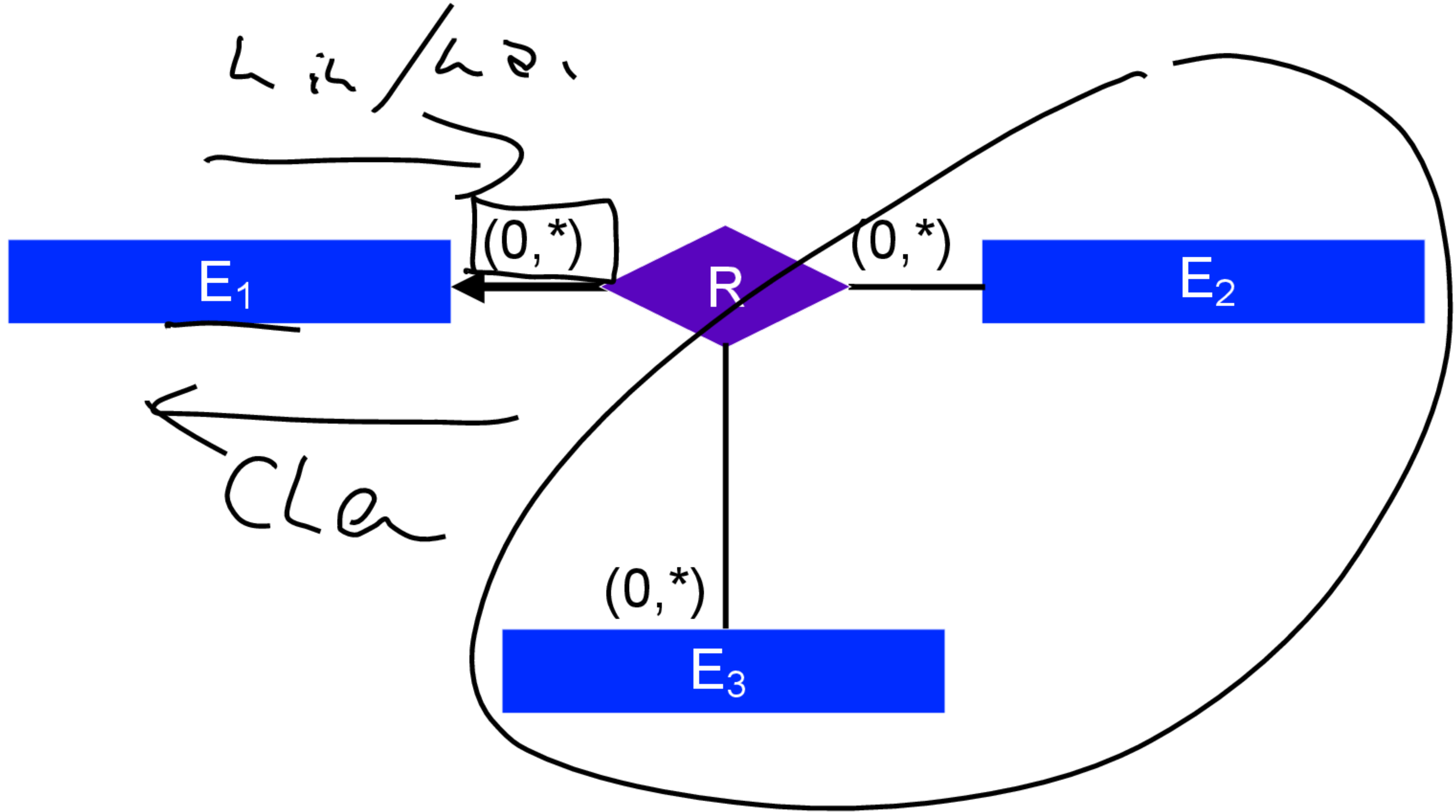

Starke Entitätstypen



Starke Entitätstypen



Schwache Entitätstypen



N:M Beziehung

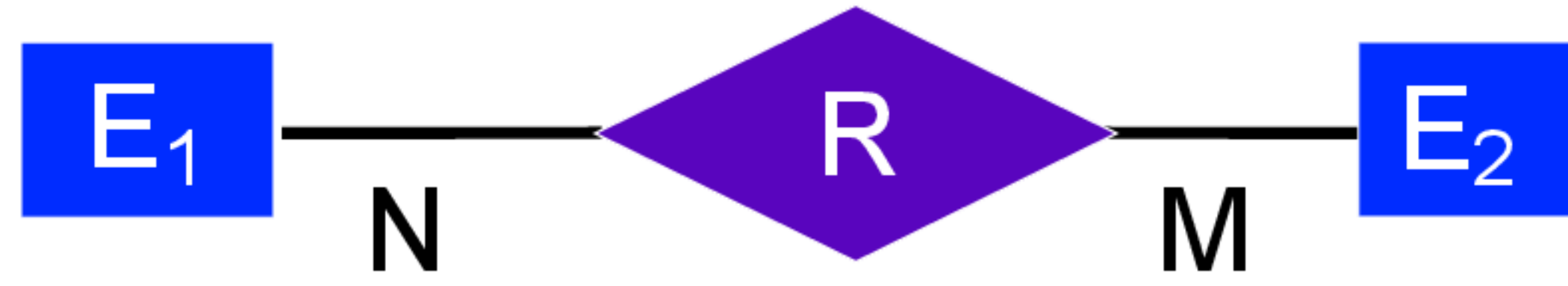

N:M Beziehung

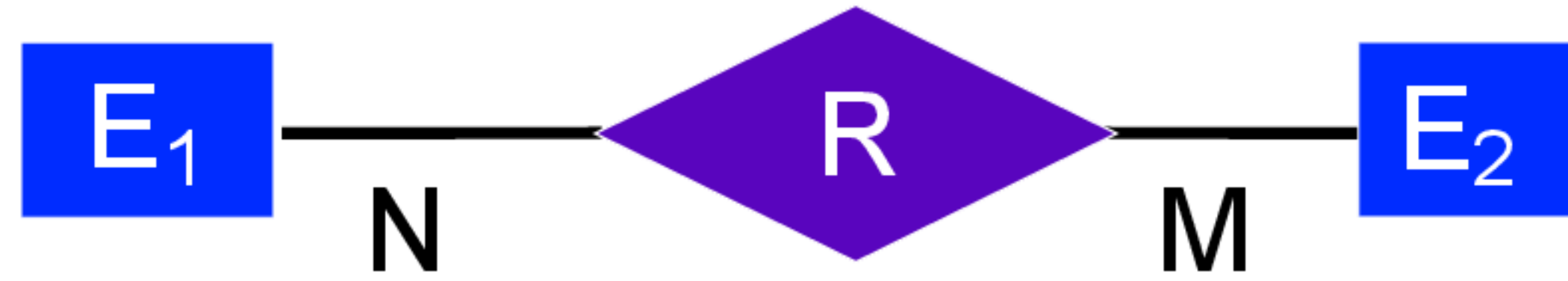

N:M Beziehung mit schwachen Entitätstypen

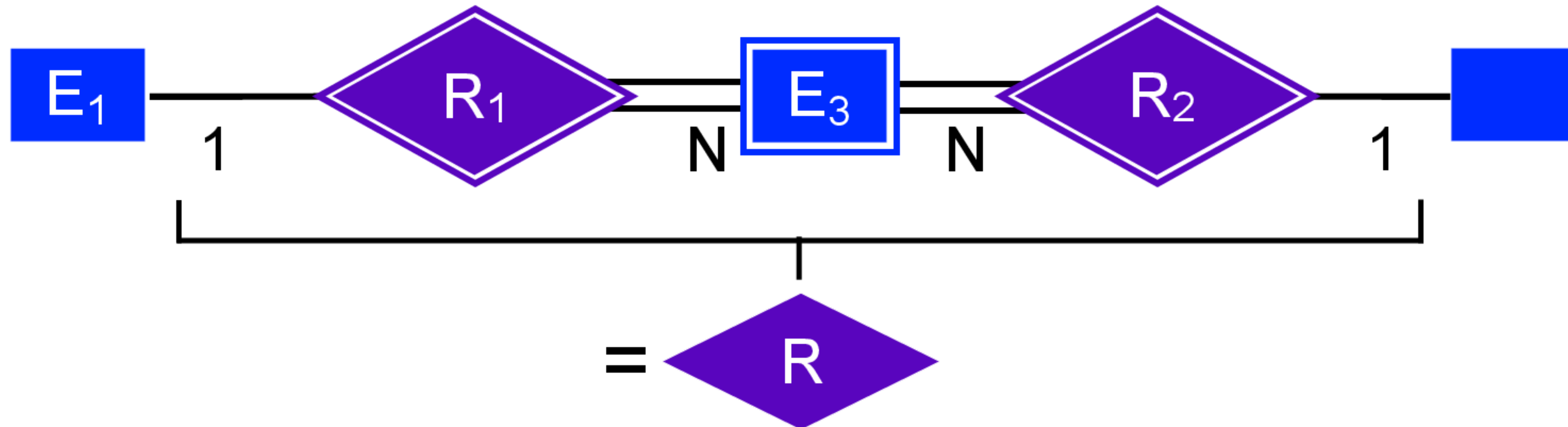

N:M Beziehung

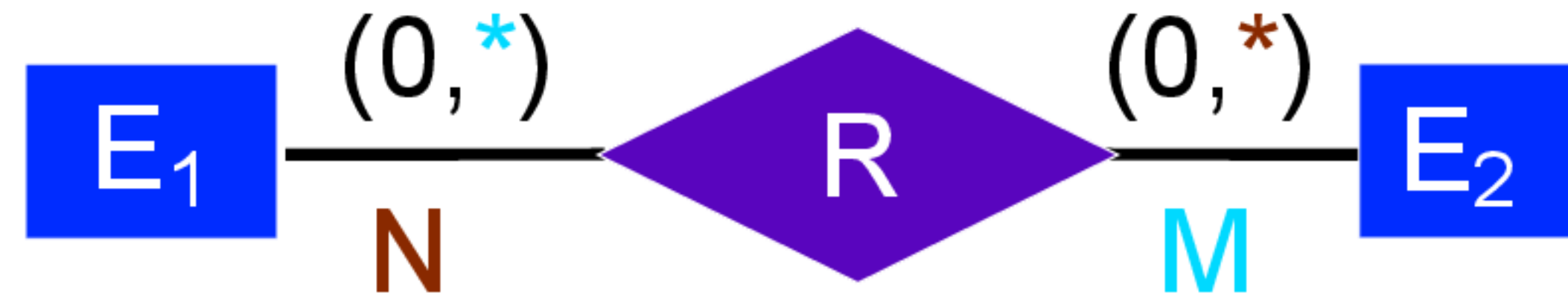

N:M Beziehung mit schwachen Entitätstypen

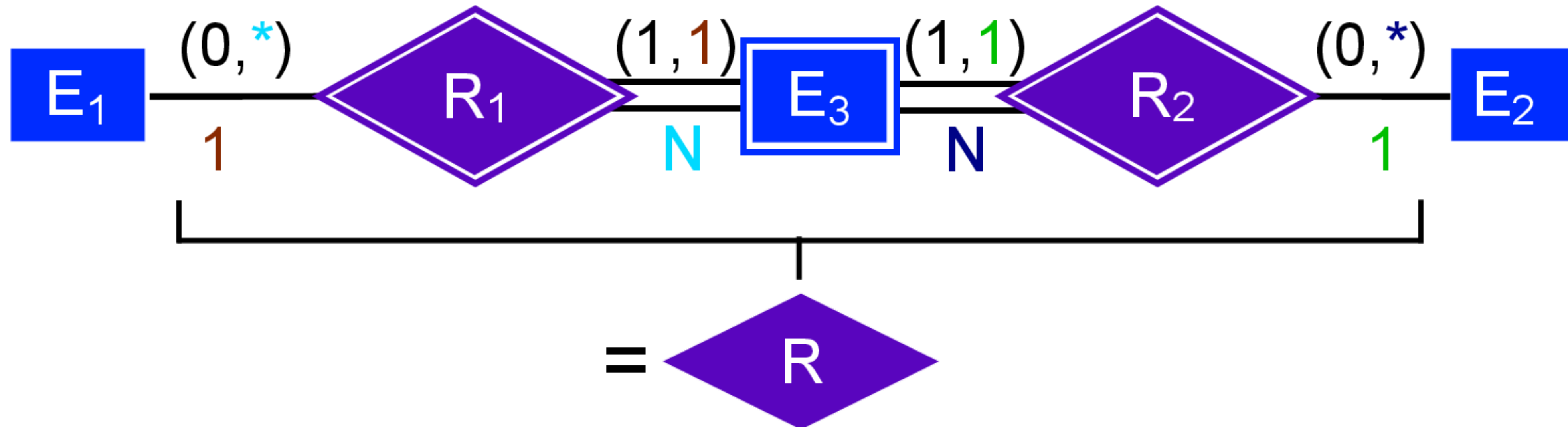

Generalisierung

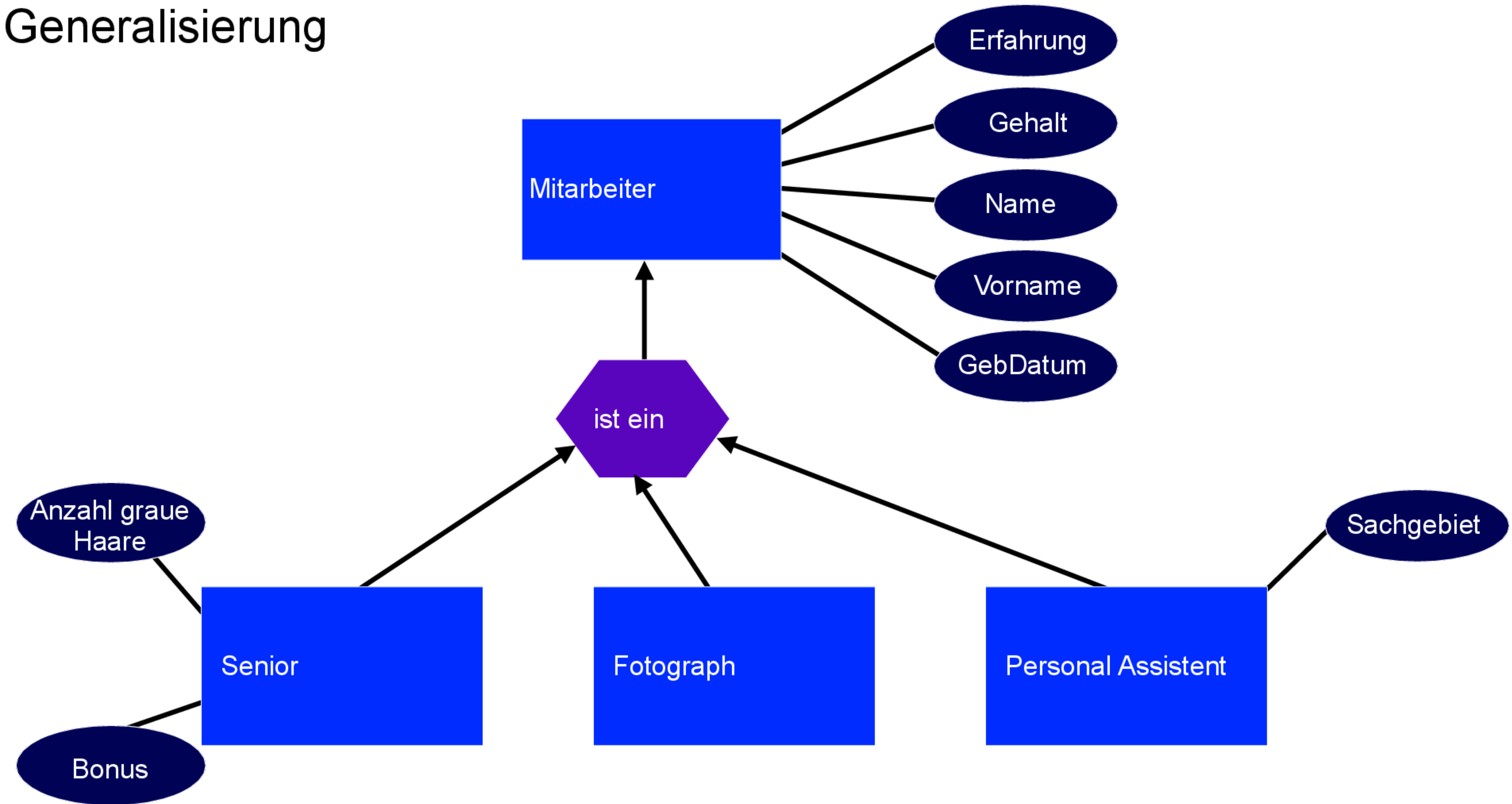

Komposition

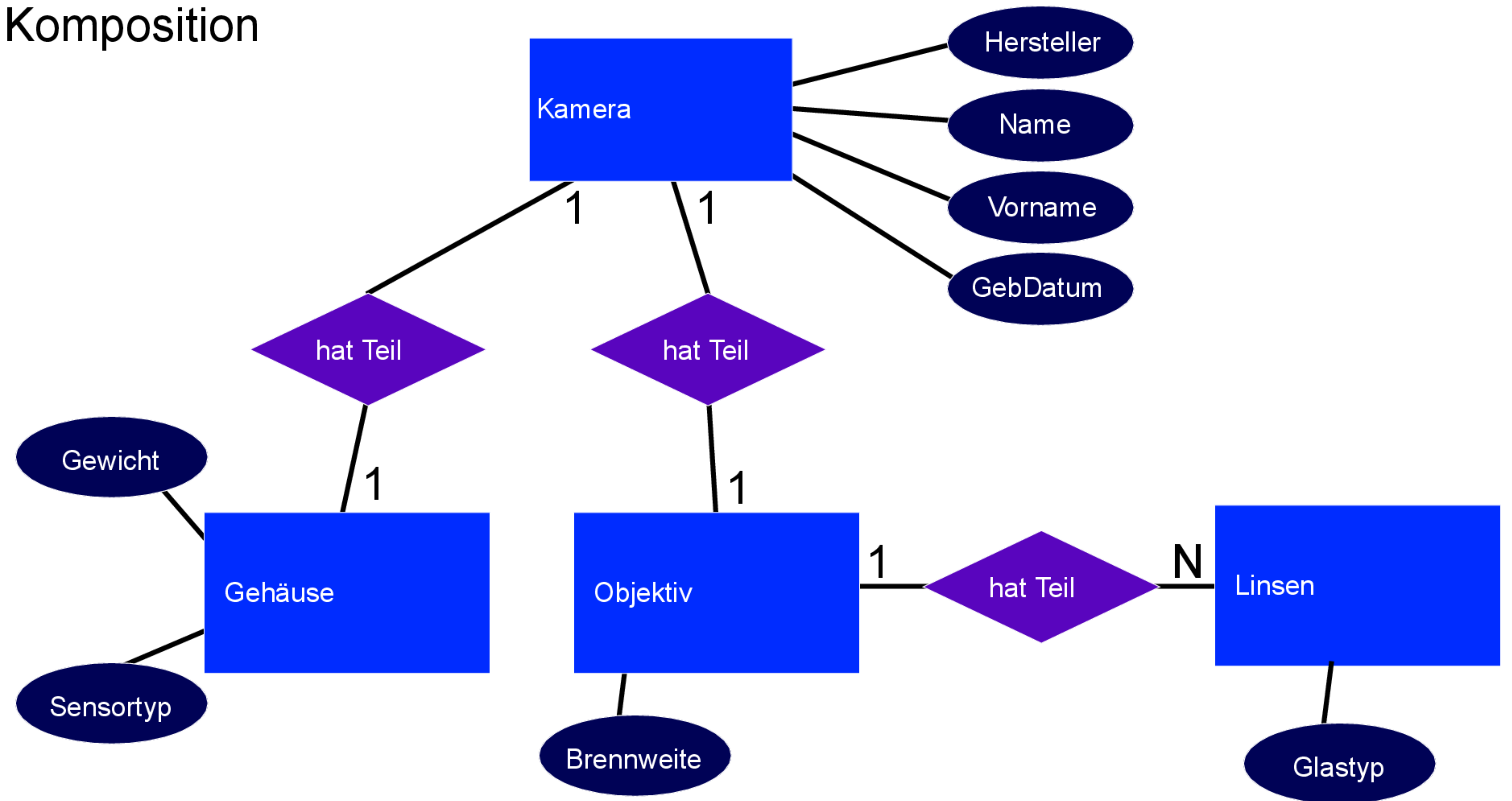

Copyrights and Credits

© **iStock.com:**

by_nicholas; Renphoto; JohnnyGreig; excentric_01; RyanJLane; aldra

other:

Jens Dittrich